

# **Gryphon™ GFS4XXX**

## **Fixed Mount Linear Imager Bar Code Reader**



## **Quick Reference Guide**

**Datalogic Scanning, Inc.**

959 Terry Street  
Eugene, Oregon 97402  
USA  
Telephone: (541) 683-5700  
Fax: (541) 345-7140

An Unpublished Work - All rights reserved. No part of the contents of this documentation or the procedures described therein may be reproduced or transmitted in any form or by any means without prior written permission of Datalogic Scanning, Inc. or its subsidiaries or affiliates ("Datalogic" or "Datalogic Scanning"). Owners of Datalogic products are hereby granted a non-exclusive, revocable license to reproduce and transmit this documentation for the purchaser's own internal business purposes. Purchaser shall not remove or alter any proprietary notices, including copyright notices, contained in this documentation and shall ensure that all notices appear on any reproductions of the documentation. Should future revisions of this manual be published, you can acquire printed versions by contacting your Datalogic representative. Electronic versions may either be downloadable from the Datalogic website ([www.scanning.datalogic.com](http://www.scanning.datalogic.com)) or provided on appropriate media. If you visit our website and would like to make comments or suggestions about this or other Datalogic publications, please let us know via the "Contact Datalogic" page.

**Disclaimer**

Datalogic has taken reasonable measures to provide information in this manual that is complete and accurate, however, Datalogic reserves the right to change any specification at any time without prior notice.

Datalogic and the Datalogic logo are registered trademarks of Datalogic S.p.A. in many countries, including the U.S.A. and the E.U. All other brand and product names may be trademarks of their respective owners.

**Patents**

This product is covered by one or more of the following patents.

US Pat.: 5,144,118; 5,311,000; 5,481,098; 5,493,108; 5,929,421; 5,992,740; 6,098,883; 6,260,764; 6,443,360 B1; 6,631,846 B2; 6,808,114 B1; 6,817,525 B2; 6,997,385 B2; 7,075,663 B2; 7,387,246 B2.

European Pat.: 789,315 B1; 926,620 B1; 962,880 B1; 997,760 B1; 1,128,315 B1; 1,164,536 B1; 1,217,571 B1; 1,396,811 B1; 1,413,971 B1.

Additional patents pending.

# Table of Contents

Setting Up the Reader .....	6
Select Interface - USB Interface .....	6
Mounting Bracket .....	8
Programming .....	10
Operating Modes .....	10
Exposure Modes .....	11
Technical Features .....	12
RS-232 Electrical Connections .....	14
LED and Beeper Indications .....	16
Button and LED Status .....	16
Ergonomic Recommendations .....	17
Regulatory Information .....	18
Reader Labeling .....	18

---

# NOTES

**GRYPHON™ PRODUCT SERIES END USER LICENSE AGREEMENT**

**Notice to End User:** The Datalogic Product you have acquired contains embedded Software, which is integral to the product's operation. This Software is being provided to you under license, subject to the terms and conditions of this Agreement. If you use the Datalogic Product, you will be deemed to have accepted the terms and conditions of this Agreement. If you do not intend to be bound to the terms of this Agreement, Datalogic is not willing to license the Software to you, you may not use the Datalogic Product or the Software, and you must contact the party from whom you acquired the Datalogic Product for instructions.

This End User Software License Agreement ("Agreement") is a legally binding agreement governing the licensing of the Software and Documentation by Datalogic Scanning, Inc. and its Affiliates ("Datalogic") to the entity or person who has purchased or otherwise acquired a Datalogic Product ("End User"). For purposes of this Agreement, any software that is associated with a separate end-user license agreement is licensed to you under the terms of that license agreement. Datalogic and End User hereby agree as follows:

**1. Definitions.**

- 1.1 "Affiliate" means a business entity currently existing or later acquired that controls, is controlled by, or is under common control with Datalogic S.p.A.
- 1.2 "Documentation" means materials such as user's guides, program reference guides, quick reference guides, manuals, or similar materials associated with or related to the Datalogic Product, whether in printed, "online", or other form.
- 1.3 "Proprietary Information" means: (a) source code, object code, software, documentation, and any related internal design, system design, data base design, algorithms, technology, technical data or information, implementation techniques, and trade secrets related to the Software, (b) any other trade secrets marked appropriately or identified as proprietary or confidential, and (c) any information that End User, under the circumstances, should recognize as confidential. Proprietary Information does not include any information that the receiving party can establish was (1) in the public domain, (2) already in the receiving party's possession or rightfully known prior to receipt, (3) rightfully learned from a third party not in violation of any other's proprietary rights, or (4) independently developed without access to Proprietary Information.
- 1.4 "Datalogic Product" means the Datalogic® Gryphon™ series scanner product, including all embedded Software in and all Documentation related to such product, which has been purchased or otherwise acquired by End User, whether obtained directly or indirectly from Datalogic.
- 1.5 "Software" means any software or computer programs of Datalogic or its third party licensors in machine readable form which is embedded in the Datalogic Product, whether obtained directly or indirectly from Datalogic, including any replacement, update, upgrade, enhancement or modification.

**2. Scope Of License Granted.**

- 2.1 Datalogic grants to End User a non-exclusive, non-transferable, perpetual license to use the Software, solely on the Datalogic Product in which it is embedded ("designated Datalogic Product"), in machine-readable form only, solely for End User's internal business purposes. This Agreement does not convey ownership of the Software to End User. Title to the Software shall be and remain with Datalogic or the third party from whom Datalogic has obtained a licensed right. As used in this Agreement, the term "purchase" or its equivalents when applied to the Software shall mean "acquire under license." End User is not entitled to receipt or use of the source code to any Software.
- 2.2 End User shall not copy, modify, decompile, disassemble, reverse engineer, or otherwise reproduce or remanufacture the Software, whether modified or unmodified, nor sell, assign, sublicense, distribute, lend, rent, give, or otherwise transfer the Software to any other person or organization, for purposes other than as expressly provided in this Agreement, without Datalogic's prior written consent.

---

### **3. Transfers, Support.**

- 3.1 Any copying, installing, reproduction, remanufacture, reverse engineering, electronic transfer, or other use of the Software on other than the designated Datalogic Product will be a material breach of this Agreement. However, Datalogic may elect not to terminate this Agreement or the granted licenses, but instead may elect to notify End User that End User is deemed to have ordered and accepted a license for each breaching use. End User shall pay Datalogic the applicable list price for such licenses as of the date of such breach.
- 3.2 End User shall not sell, assign, sublicense, distribute, lend, rent, give, or otherwise transfer the Datalogic Product to any third party unless such third party agrees with Datalogic in writing to be bound by the terms and conditions of this Agreement. Any such transfer of the Datalogic Product absent such agreement shall be null and void.
- 3.3 End User may obtain support for Software from Datalogic at Datalogic's standard support fees and under Datalogic's standard support terms and conditions in effect at the time the support is requested.

### **4. Intellectual Property.**

End User acknowledges that the Software constitutes valuable trade secrets of Datalogic or Datalogic's third party licensors and that the Software is protected by intellectual property laws and treaties. The license set forth in this Agreement does not transfer to End User any ownership of Datalogic's or its third party licensors' copyrights, patents, trademarks, service marks, trade secrets, or other intellectual property rights and End User shall have no right to commence any legal actions to obtain such rights. End User shall not remove, modify, or take any other action that would obscure any copyright, trademark, patent marking, or other intellectual property notices contained in or on the Datalogic Product.

### **5. Proprietary Information.**

- 5.1 End User acknowledges that Proprietary Information is the confidential, proprietary, and trade secret property of Datalogic and Datalogic's third party licensors and End User acquires no right or interest in any Proprietary Information.
- 5.2 End User shall not disclose, provide, or otherwise make available the Proprietary Information of Datalogic or its third party licensors to any person other than End User's authorized employees or agents who are under confidentiality agreement, and End User shall not use the Proprietary Information other than in conjunction with use of the Datalogic Product exclusively for End User's internal business purposes. End User shall take steps to protect the Proprietary Information no less securely than if it were End User's own intellectual property.
- 5.3 The provisions of this Proprietary Information Section shall survive and continue for five (5) years after the termination of this Agreement.

### **6. Limited Warranty.**

- 6.1 Datalogic warrants that, under normal use and operation, the Datalogic Product will conform substantially to the applicable Documentation for the period specified in the Documentation. During this period, for all reproducible nonconformities for which Datalogic has been given written notice, Datalogic will use commercially reasonable efforts to remedy nonconformities verified by Datalogic. End User agrees to supply Datalogic with all reasonably requested information and assistance necessary to help Datalogic in remedying such nonconformities. For all defects reported to Datalogic within the warranty period, Datalogic's liability is limited to providing End User with one copy of corrections or responding to End User's problem reports according to Datalogic's standard assistance practices. Datalogic does not warrant that the product will meet End User's requirements or that use of the product will be uninterrupted or error free, or that Datalogic's remedial efforts will correct any nonconformance. This limited warranty does not cover any product that have been subjected to damage or abuse, whether intentionally, accidentally, or by neglect, or to unauthorized repair or unauthorized installation, and shall be void if End User modifies the product, uses the product in any manner other than as established in the Documentation, or if End User breaches any of the provisions of this Agreement.
- 6.2 EXCEPT AS PROVIDED IN THIS AGREEMENT, THE DATALOGIC PRODUCT IS PROVIDED "AS IS" AND DATALOGIC MAKES NO WARRANTIES OF ANY KIND, EXPRESS OR IMPLIED, WRITTEN OR ORAL,

---

WITH RESPECT TO THE PRODUCT, AND SPECIFICALLY DISCLAIMS THE IMPLIED WARRANTIES OF MERCHANTABILITY AND FITNESS FOR A PARTICULAR PURPOSE.

## **7. Infringement.**

- 7.1 Datalogic will defend End User against any claim in a lawsuit that the Datalogic Product furnished hereunder infringe a United States patent or copyright of a third party and Datalogic will pay any damages finally awarded against End User by a court of competent jurisdiction that are attributable to such claim or will pay End User's part of any settlement that is attributable to such claim, provided, that 1) End User notifies Datalogic promptly in writing of the claim, 2) Datalogic controls the defense or settlement of the claim, and 3) End User cooperates fully with Datalogic in such defense or settlement. All notices of a claim should be sent to Datalogic Scanning, Inc., Legal Department, 959 Terry Street, Eugene, OR 97402.
- 7.2 In the defense or settlement of any such claim, Datalogic may, at its option, 1) procure for End User the right to continue using the Datalogic Product, 2) modify the Datalogic Product so that it becomes non-infringing, 3) replace the Datalogic Product with an equivalent product not subject to such claim, or 4) provide End User an opportunity to return the Datalogic Product and receive a refund of the purchase price paid, less a reasonable allowance for use.
- 7.3 Datalogic shall have no liability to End User for claims of infringement based upon 1) the use of any Datalogic Product in combination with any product which Datalogic has not either furnished or authorized for use with such Datalogic Product 2) the use of any Datalogic Product designed, manufactured, or modified to the specifications of End User, or 3) End User's modification of the Datalogic Product without written authorization from Datalogic.
- 7.4 THE FOREGOING STATES DATALOGIC'S COMPLETE AND ENTIRE OBLIGATION CONCERNING CLAIMS OF PATENT, COPYRIGHT, OR OTHER INTELLECTUAL PROPERTY INFRINGEMENT, CANCELS AND SUPERCEDES ANY PRIOR AGREEMENTS, WHETHER ORAL OR WRITTEN, BETWEEN THE PARTIES CONCERNING SUCH CLAIMS, AND WILL NOT BE MODIFIED OR AMENDED BY ANY PAST, CONTEMPORANEOUS, OR FUTURE AGREEMENTS OR DEALINGS BETWEEN THE PARTIES, WHETHER ORAL OR WRITTEN, EXCEPT AS SET FORTH IN A FUTURE WRITING SIGNED BY BOTH PARTIES.

## **8. Limitation Of Liability.**

EXCEPT AS PROVIDED IN SECTION 7, DATALOGIC SHALL NOT BE LIABLE FOR ANY CLAIMS AGAINST END USER BY ANY OTHER PARTY. IN NO EVENT SHALL DATALOGIC'S LIABILITY FOR DAMAGES, IF ANY, WHETHER BASED UPON CONTRACT, TORT (INCLUDING NEGLIGENCE), PRODUCT LIABILITY, STRICT LIABILITY, WARRANTY, OR ANY OTHER BASIS, EXCEED THE PRICE OR FEE PAID BY END USER FOR THE DATALOGIC PRODUCT. UNDER NO CIRCUMSTANCES SHALL DATALOGIC BE LIABLE TO END USER OR ANY THIRD PARTY FOR LOST PROFITS, LOST DATA, INTERRUPTION OF BUSINESS OR SERVICE, OR FOR ANY OTHER SPECIAL, CONSEQUENTIAL, CONTINGENT, INDIRECT, INCIDENTAL, PUNITIVE, EXEMPLARY, OR OTHER SIMILAR DAMAGES, EVEN IF DATALOGIC HAS BEEN ADVISED OF THE POSSIBILITY OF SUCH DAMAGES.

## **9. Government Restricted Rights; International Use.**

- 9.1 Use, duplication, or disclosure of the Software by the U.S. Government is subject to the restrictions for computer software developed at private expense as set forth in the U.S. Federal Acquisition Regulations at FAR 52.227-14(g), or 52.227-19 or in the Rights in Technical Data and Computer Software clause at DFARS 252.227-7013(c)(1)(ii), whichever is applicable.
- 9.2 If End User is using the Datalogic Product outside of the United States, End User must comply with the applicable local laws of the country in which the Datalogic Product is used, with U.S. export control laws, and with the English language version of this Agreement. The provisions of the "United Nations Convention on International Sale of Goods" shall not apply to this Agreement.

## **10. Termination.**

- 10.1 Either party may terminate this Agreement or any license granted under this Agreement at any time upon written notice if the other party breaches any provision of this Agreement.

---

10.2 Upon termination of this Agreement, End User immediately shall cease using any nonembedded software and shall return to Datalogic or destroy all non-embedded software covered by this Agreement, and shall furnish Datalogic with a certificate of compliance with this provision signed by an officer or authorized representative of End User. For embedded software, End User agrees to sign a waiver prepared by Datalogic concerning further use of the embedded Software. End User's resumed or continued use of the embedded Software after termination shall constitute End User's agreement to be bound by the terms and conditions of this Agreement for such use.

#### **11. General Provisions.**

11.1 Entire Agreement; Amendment. This document contains the entire agreement between the parties relating to the licensing of the Software and supersedes all prior or contemporaneous agreements, written or oral, between the parties concerning the licensing of the Software. This Agreement may not be changed, amended, or modified except by written document signed by Datalogic.

11.2 Notice. All notices required or authorized under this Agreement shall be given in writing, and shall be effective when received, with evidence of receipt. Notices to Datalogic shall be sent to the attention of Contract Administration, Datalogic Scanning, Inc., 959 Terry Street, Eugene, OR 97402, or such other address as may be specified by Datalogic in writing.

11.3 Waiver. A party's failure to enforce any of the terms and conditions of this Agreement shall not prevent the party's later enforcement of such terms and conditions.

11.4 Governing Law; Venue: This Agreement and the rights of the parties hereunder shall be governed by and construed in accordance with the laws of the State of Oregon U.S.A, without regard to the rules governing conflicts of law. The state or federal courts of the State of Oregon located in either Multnomah or Lane counties shall have exclusive jurisdiction over all matters regarding this Agreement, except that Datalogic shall have the right, at its absolute discretion, to initiate proceedings in the courts of any other state, country, or territory in which End User resides, or in which any of End User's assets are located.

11.5 Attorneys' Fees. In the event an action is brought to enforce the terms and conditions of this Agreement, the prevailing party shall be entitled to reasonable attorneys' fees, both at trial and on appeal.

- END -

### **Software Product Policy**

Datalogic reserves the right to ship its products with the latest version of software/firmware available. This provides our customers with the very latest in Datalogic software technology.

The only exception to this policy is when the buyer has a signed contract with Datalogic that clearly defines the terms and conditions for making software/firmware changes in products shipped to the buyer.

### **Customers Under Software Support**

Customers that elect to subscribe to Datalogic Software Maintenance and Support Agreement will receive 30 days advance notification of: (1) the release of a new software version; and/or (2) discontinuation of any prior software version that will no longer be supported. Datalogic will provide maintenance for a fee that will assist customers in transitioning to the next software version. If a customer is currently using the software version being discontinued, the customer may elect to transition to any one of the newer versions, depending on the hardware in use.

To arrange for a Software Maintenance and Support Agreement please contact your Datalogic sales person.



# Gryphon GFS4XXX

## Fixed Mount Linear Imager

### Bar Code Reader

The Gryphon GFS4XXX is a fully self-contained standard range 1D bar code scanning module for use in self service kiosks or other semi automated equipment requiring the ability to read a bar code. It is intended to be an easy integration by system designers with little expertise in scanning technology. Unlike currently available products, the GFS4XXX uses the latest and fastest imaging technology and offers Datalogic's Green Spot for targeting and good read feedback.

The scanning technology is essentially the same as the Gryphon I 4100 family of linear imagers, with some adjustments made for read range and improved motion tolerance. The enclosure is designed for ease of integration, is sealed to IP54 for cleaning, and is constructed of a solvent- and disinfectant-tolerant resin for health care applications.

The GFS4XXX is a linear CCD Scanner for OEM applications. It is available in two different models:

- GFS4170 Gryphon Fixed Scanner imager USB
- GFS4150-9 Gryphon Fixed Scanner imager RS-232 9 pin connector

---

## Setting Up the Reader

### Select Interface - USB Interface

The reader (GFS4170 model only) attaches directly to a USB host or a powered USB hub, and is powered by it. No additional power supply is required. The reader auto-detects the USB and defaults to the HID keyboard interface.

To simulate a Keyboard, scan the bar code below:

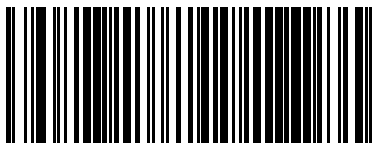

Interface Selection: USB-KBD (GFS4170 model only)

To simulate an RS-232 Standard Interface scan the bar code below:

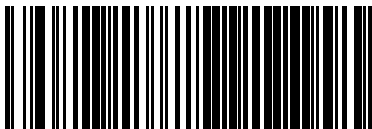

Interface Selection: USB-COM (GFS4170 Model only)



**IMPORTANT**

**Download the correct USB COM driver from:  
<http://www.datalogic.com>.**

Select USB Keyboard with alternate key encoding:

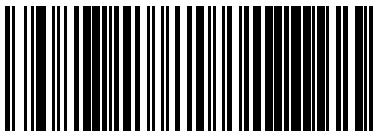

USB Alternate Keyboard

Select USB Keyboard for Apple computers:



USB-KBD-APPLE

Select RS-232 Wincor-Nixdorf:

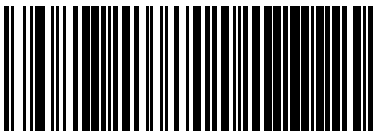

RS-232 Wincor-Nixdorf

## Mounting Bracket

The GFS4XXX can be mounted to a stationary surface using a bracket as shown below. Just attach to the bottom of the reader using screws, as shown in the next two figures.

**Figure 1. Mounting the bracket**

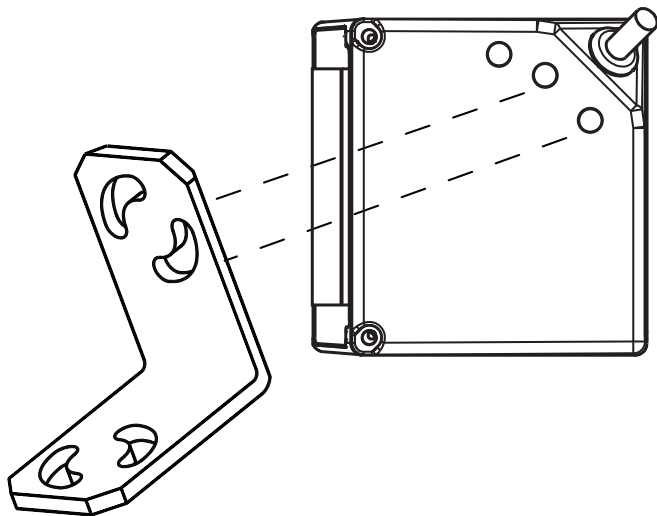

**Figure 2. Bracket Attached**

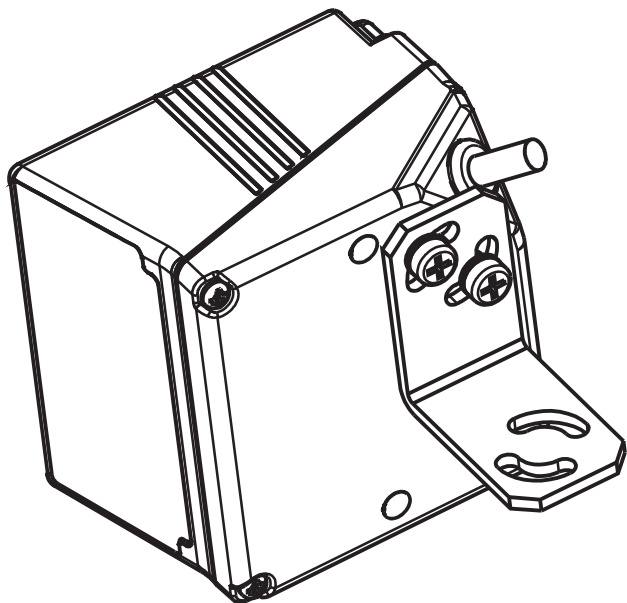

---

## Programming

For your convenience, this guide includes the programming bar codes required to configure the reader.

If you aren't sure what programming options are in your reader, or you've changed some options and want the factory settings restored, scan the bar code below:



Restore Default Settings

## Operating Modes

The reader can operate in one of several scanning modes:

**On Line** — Scanning is activated when the button is pushed or through an external trigger (GFS4150-9 only).

**Automatic** — Scanning is continually on.

**Automatic (Object Sense)** — Scanning is turned on automatically when an item is placed in reader's field of view.

**Strobe Exposure Mode** — For any selectable scanning mode, performance on moving bar codes can be improved by flashing the scanner's lighting (strobe mode). The scanner strobes at a very high frequency, so the change in lighting may not be apparent. When enabled, the scanner can read codes moving at up to 1m/sec, depending on the bar size and direction the code is moving.

---

## Operating Modes (continued)

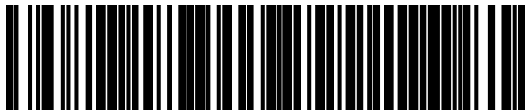

Operating Mode = On Line



Operating Mode = Automatic

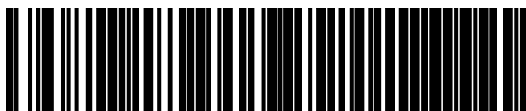

Operating Mode = Automatic (Object Sense)

## Exposure Modes



Continuous



Strobed

## Technical Features

Item	Description
<b>Physical Characteristics</b>	
<b>Color</b>	Grey
<b>Dimensions</b>	Height 1.54" / 39mm Length 2.24" / 57mm Width 2.28" / 58 mm
<b>Weight (without cable and brackets)</b>	USB model - Approx. 5.0 ounces/140 g RS-232 model - approx. 6.0 ounces/170 g
<b>Electrical Characteristics</b>	
<b>Input Voltage</b>	5 VDC $\pm$ 5%
<b>External Trigger Input</b>	5 $\div$ 30 VDC (Only GFS4150-9)
<b>Output</b>	Vmax = 30VDC (Only GFS4150-9)
<b>Current &amp; Power Consumption</b>	Input current at 5V = 390 mA (max) <2.5 mA (GFS4170 model in USB suspend)
<b>Performance Characteristics</b>	
<b>Scan rate</b>	320 scans/s (max)
<b>Light Source</b>	Dual LEDs (Red Light, $\lambda$ =620 nm)
<b>Roll Angle Tolerance</b>	$\pm$ 35°
<b>Pitch Angle Tolerance</b>	$\pm$ 65° (Avoid zero angle, $\pm$ 6°)
<b>Skew Angle Tolerance</b>	$\pm$ 65°



Item	Description
<b>Depth of Field (Typical)</b>	5 mil - 2" to 6.3" (5cm to 16cm) 8 mil - 1.2" to 10.6" (3cm to 27cm) 13 mil* - 1.2" to 15.7" (3cm to 40 cm) 20 mil - up to 23.6" (up to 60 cm)
<b>Minimum Element Width</b>	3 mil
<b>Print Contrast Minimum</b>	15% minimum reflectance
<b>Decode Capability</b>	UPC/EAN/JAN A, E, 13, 8 (including P2 /P5, ISBN / Bookland & ISSN); Code 39 (including full ASCII); Code 39 CIP (French Pharmaceutical); Code 128; I 2 of 5; Standard 2 of 5; China Post Code (DLS 2 of 5); IATA Industrial 2 of 5 Air Cargo Code; Codabar; ABC Codabar; GS1 - 128; Code ISBT 128; MSI; Plessey; DATABAR-14; DATABAR Limited; DATABAR-14 Stacked; DATABAR Expanded Stacked; Code32 (Italian Pharmacode); China Post (DLS 2 of 5).
<b>Interfaces Supported</b>	GFS4150-9 model: RS-232 Standard GFS4170 model:USB COM Standard, USB Keyboard
<b>User Environment</b>	
<b>Operative Temperature</b>	32° to 122° F (0° to 50° C)
<b>Storage Temperature</b>	-13° to 158° F (-25° to 70° C)
<b>Humidity</b>	Operating: 5% to 90% relative humidity, non condensing
<b>Drop specifications</b>	5 drops from 30 inches (0.76 mt.) to concrete
<b>Ambient Light immunity</b>	Up to 100,000 Lux

Item	Description
<b>Contaminants</b>	IP54
<b>ESD Level</b>	16 KV
<b>Regulatory</b>	
<b>Led Emission Class</b>	(IEC-62471:2006-07) Exempt (No Risk)
<b>Electrical Safety</b>	IEC 60950-1 , CAN/CSA-C22.2 No. 60950-1-03; UL 60950-1
<b>EMI/RFI</b>	North America (FCC) : Part 15 Class B, Canada ( IC ) : ICES-003 Class B, European Union EMC Directive, Australian (C-tick), Russia (Gost)

\* (13 mils DOF based on EAN. All others are Code 39. All labels grade A, minimum illumination 100 lux, 20°C, label inclination 10°, static reading).

## RS-232 Electrical Connections

### 9-pin connector

1	Trigger	Trigger signal input (see <a href="#">Figure 4</a> and <a href="#">Figure 5</a> on next page)
2	TX	Transmit Data
3	RX	Receive Data
4	NC	Not connected
5	GND	Ground
6	VCC	+5Vdc
7	CTS	Clear To Send
8	RTS	Request To Send
9	OUT	Output signal (see <a href="#">Figure 3</a> )

Default configuration RS-232: 9600, 8, N, 1, no handshaking, ACK/NAK disabled.

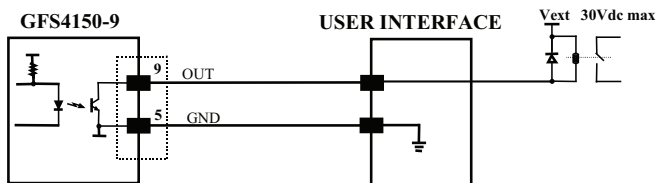
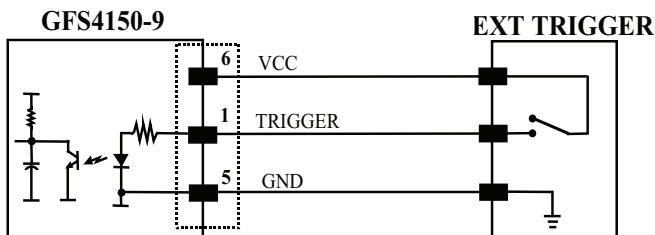
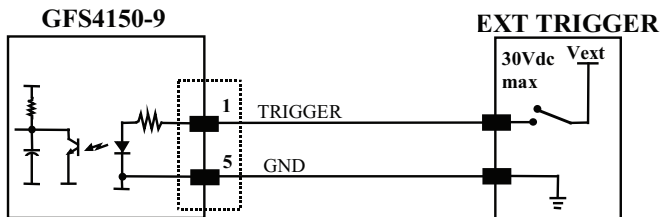
**Figure 3. Output Connection**

**Figure 4. Using GFS4150-9 Power**

**Figure 5. Using External Power Supply**

## LED and Beeper Indications

### Button and LED Status

The top of the product has a button and three indicator LEDs:

	POWER (yellow LED)	ON = Power ON
		OFF = Power OFF or standby (only USB model)
	GOOD (green LED)	ON = Good Read
		Blinks = USB enumeration or interface inactive or waiting for change of configuration
	TRIGGER (blue LED)	ON = external trigger or button pressed or phase active
	Button	Press for manual trigger

## Ergonomic Recommendations



**In order to avoid or minimize the potential risk of ergonomic injury follow the recommendations below. Consult with your local Health & Safety Manager to ensure that you are adhering to your company's safety programs to prevent employee injury.**

**CAUTION**

- Reduce or eliminate repetitive motion
- Maintain a natural position
- Reduce or eliminate excessive force
- Keep objects that are used frequently within easy reach
- Perform tasks at correct heights
- Reduce or eliminate vibration
- Reduce or eliminate direct pressure
- Provide adjustable workstations
- Provide adequate clearance
- Provide a suitable working environment
- Improve work procedures.

## Regulatory Information

All models are designed to be compliant with rules and regulations in locations they are sold and will be labeled as required.

Any changes or modifications to equipment, not expressly approved by Datalogic could void the user's authority to operate the equipment.

## Reader Labeling

Labels are shown here to illustrate their location only. Please view the labels on your product for actual details.

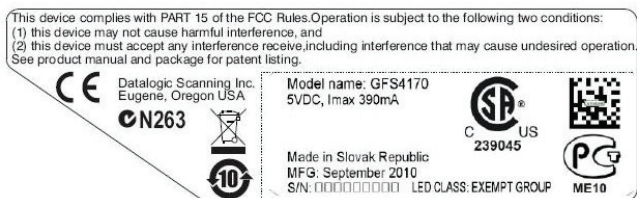

**Waste Electrical and Electronic Equipment (WEEE) Statement****English**

For information about the disposal of Waste Electrical and Electronic Equipment (WEEE), please refer to the website at [www.scanning.datalogic.com](http://www.scanning.datalogic.com).

**Italian**

Per informazioni sullo smaltimento delle apparecchiature elettriche ed elettroniche consultare il sito Web [www.scanning.datalogic.com](http://www.scanning.datalogic.com).

**French**

Pour toute information relative à l'élimination des déchets électroniques (WEEE), veuillez consulter le site internet [www.scanning.datalogic.com](http://www.scanning.datalogic.com).

**German**

Informationen zur Entsorgung von Elektro- und Elektronik- Altgeräten (WEEE) erhalten Sie auf der Webseite [www.scanning.datalogic.com](http://www.scanning.datalogic.com).

**Spanish**

Si desea información acerca de los procedimientos para el desecho de los residuos del equipo eléctrico y electrónico (WEEE), visite la página Web [www.scanning.datalogic.com](http://www.scanning.datalogic.com).

**Portuguese**

Para informações sobre a disposição de Sucatagem de Equipamentos Elétricos e Eletrônicos (WEEE -Waste Electrical and Electronic Equipment), consultar o site web [www.scanning.datalogic.com](http://www.scanning.datalogic.com).

**Chinese**

有关处理废弃电气电子设备 (WEEE) 的信息, 请参考 Datalogic 公司的网站: <http://www.scanning.datalogic.com/>。

**Japanese**

廃電気電子機器 (W E E E) の処理についての関連事項は Datalogic のサイト [www.scanning.datalogic.com](http://www.scanning.datalogic.com) をご参照下さい。

## Warranty

Datalogic warrants to Customer that Datalogic's products will be free from defects in materials and workmanship for a period of one (1) year from product shipment. This warranty does not extend to batteries and cables. As consumable items batteries and cables carry a 90 day warranty from time of purchase for DOA (dead on arrival) defects. In order to obtain service under this Warranty, Customer must notify Datalogic of the claimed defect before the expiration of the Warranty period and obtain from Datalogic a return authorization number for return of the product to designated Datalogic service center. If Datalogic determines Customer's claim is valid, Datalogic will repair or replace product without additional charge for parts and labor. Customer shall be responsible for packaging and shipping the product to the designated Datalogic service center, with shipping charges prepaid. Datalogic shall pay for the return of the product to Customer if the shipment is to a location within the country in which the Datalogic service center is located. Customer shall be responsible for paying all shipping charges, duties, taxes, and any other charges for products returned to any other locations.

Warranty is subject to the limitations and exclusions set forth in the paragraphs that follow.

WARRANTY SET FORTH ABOVE IS IN LIEU OF ANY OTHER WARRANTIES, EXPRESS OR IMPLIED, INCLUDING MERCHANTABILITY AND FITNESS.

## Exclusions

Warranty coverage shall not apply to any claimed defect, failure or damage which Datalogic determines was caused by: improper use of product; failure to provide product maintenance, including but not limited to cleaning of the upper window in accordance with product manual; installation or service of product by other than Datalogic representatives; use of product with any other instrument, equipment or apparatus; modification or alteration of product. External cables and replacement of upper window/cartridge due to scratching, stains or other degradation will not be covered under the Warranty. External power supplies returned for service must be accompanied by the original product for performance of service.

## Limitation of Liability

Datalogic's REPAIR OR REPLACEMENT OF DEFECTIVE PRODUCT AS SET FORTH ABOVE IS THE CUSTOMER'S SOLE AND EXCLUSIVE REMEDY ON ACCOUNT OF CLAIMS OF BREACH OF WARRANTY OR PRODUCT DEFECT. UNDER NO CIRCUMSTANCES WILL Datalogic BE LIABLE TO CUSTOMER OR ANY THIRD PARTY FOR ANY LOST PROFITS, OR ANY INCIDENTAL, CONSEQUENTIAL IN-DIRECT, SPECIAL OR CONTINGENT DAMAGES REGARDLESS OF WHETHER Datalogic HAD ADVANCE NOTICE OF THE POSSIBILITY OF SUCH DAMAGES.



## Assignment

Customer may not assign or otherwise transfer its rights or obligations under Warranty except to a purchaser or transferee of product. No attempted assignment or transfer in violation of this provision shall be valid or binding upon Datalogic.

## Risk of Loss

Customer shall bear risk of loss or damage for product in transit to Datalogic. Datalogic shall assume risk of loss or damage for product in Datalogic's possession or product being returned to Customer by Datalogic, except such loss or damage as may be caused by the negligence of Customer, its agents or employees. In the absence of specific written instructions for the return of product to Customer, Datalogic will select the carrier, but Datalogic shall not thereby assume any liability in connection with the return shipment.

# NOTES



**Datalogic Scanning Group Srl**  
**Via S. Vitalino, 13**  
**Lippo di Calderara di Reno (BO)**  
**40012 Italy**

*dichiara che*  
*declares that the*  
*déclare que le*  
*bescheinigt, daß das Gerät*  
*declare que el*

**Gryphon GFS41XX**

*e tutti i suoi modelli*  
*and all its models*  
*et tous ses modèles*  
*und seine Modelle*  
*y todos sus modelos*

*sono conformi alle Direttive del Consiglio Europeo sottoelencate:*  
*are in conformity with the requirements of the European Council Directives listed below:*  
*sont conformes aux spécifications des Directives de l'Union Européenne ci-dessous:*  
*den nachstehenden angeführten Direktiven des Europäischen Rats:*  
*cumple con los requisitos de las Directivas del Consejo Europeo, según la lista siguiente:*

**2004/108/EC EMC Directive**

*Basate sulle legislazioni degli Stati membri in relazione alla compatibilità elettromagnetica ed alla sicurezza dei prodotti.*  
*On the approximation of the laws of Member States relating to electromagnetic compatibility and product safety.*  
*Basée sur la législation des Etats membres relative à la compatibilité électromagnétique et à la sécurité des produits.*  
*Über die Annäherung der Gesetze der Mitgliedsstaaten in bezug auf elektromagnetische Verträglichkeit und Produktsicherheit entsprechen.*  
*Basado en la aproximación de las leyes de los Países Miembros respecto a la compatibilidad electromagnética y las Medidas de seguridad relativas al producto.*

---

*Questa dichiarazione è basata sulla conformità dei prodotti alle norme seguenti:*  
*This declaration is based upon compliance of the products to the following standards:*  
*Cette déclaration repose sur la conformité des produits aux normes suivantes:*  
*Diese Erklärung basiert darauf, daß das Produkt den folgenden Normen entspricht:*  
*Esta declaración se basa en el cumplimiento de los productos con las siguientes normas:*

EN 55022 (CLASS B ITE), SEPTEMBER 2006:

LIMITS AND METHODS OF MEASUREMENTS OF RADIO DISTURBANCE CHARACTERISTICS OF INFORMATION TECHNOLOGY EQUIPMENTS

EN 55024, SEPTEMBER 1998:  
AMENDMENT A1:2001+A2:2003

INFORMATION TECHNOLOGY EQUIPMENT  
IMMUNITY CHARACTERISTICS  
LIMITS AND METHODS OF MEASUREMENT

Lippo di Calderara, November 9th, 2010

Ruggero Cacioppo  
Quality Assurance Manager



**Australia**

Datalogic Scanning Pty Ltd  
Telephone: [61] (2) 9870 3200  
australia.scanning@datalogic.com

**France and Benelux**

Datalogic Scanning SAS  
Telephone: [33].01.64.86.71.00  
france.scanning@datalogic.com

**Germany**

Datalogic Scanning GmbH  
Telephone: 49 (0) 61 51/93 58-0  
germany.scanning@datalogic.com

**India**

Datalogic Scanning India  
Telephone: 91- 22 - 64504739  
india.scanning@datalogic.com

**Italy**

Datalogic Scanning SpA  
Telephone: [39] (0) 39/62903.1  
italy.scanning@datalogic.com

**Japan**

Datalogic Scanning KK  
Telephone: 81 (0)3 3491 6761  
japan.scanning@datalogic.com

**Latin America**

Datalogic Scanning, Inc  
Telephone: (305) 591-3222  
latinamerica.scanning@datalogic.com

**Singapore**

Datalogic Scanning Singapore PTE LTD  
Telephone: (65) 6435-1311  
singapore.scanning@datalogic.com

**Iberia**

Datalogic Scanning SAS Sucursal en España  
Telephone: 34 91 746 28 60  
spain.scanning@datalogic.com

**United Kingdom**

Datalogic Scanning LTD  
Telephone: 44 (0) 1582 464900  
uk.scanning@datalogic.com



[www.scanning.datalogic.com](http://www.scanning.datalogic.com)

**Datalogic Scanning, Inc.**

959 Terry Street  
Eugene, OR 97402  
USA  
Telephone: (541) 683-5700  
Fax: (541) 345-7140

